

Specification sheet

REV.2

CLASSIC 75 FD SQ GEN 2

3 " Architectural Downlight

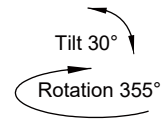
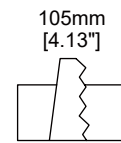
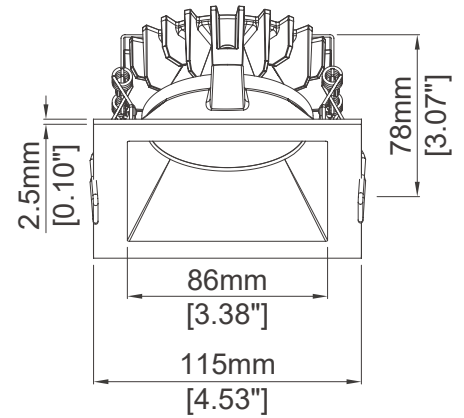

Description

Classic 75 AJ is a versatile gimbal-adjustable recessed downlight with integrated dimmable class 2 driver. The die-cast LED engine and trim construction presents a sharp and sleek look. This luminaire features functional adjustability, 30° tilt and 355° rotation, and options for four different beam angles. Classic 75 AJ comes with 5 year warranty and it is one of the best value downlights we offer.

Features

LED	Lumiled Luxeon COB1203
Color temperature	2700K/ 3000K/ 3500K/ 4000K
Optics	Spot 20° / Medium 31° / Wide 41° / Flood 80°
Driver	Remote Class 2 driver, power factor >0.90

Performance

Delivered output	Up to 850 lm(90+ CRI)
Power consumption	9 W
Color consistency	3SDCM
Color rendering	90+CRI
CBCP	Spot 3435 cd / Medium 2316 cd / Wide 1556 cd / Flood 446 cd
Lumen Maintenance	L80 B10 50,000 Hours

Electrical and Control

Input voltage	See the ordering code
Control	TRIAC / ELV
Feature	Overload & short circuit protection.

Construction

Material	Die-Cast Aluminum
Finishes	White / Black
Optics	Field Interchangeable optics

Rating/ Certification/ Warranty

- Dry and damp Locations
- RoHS compliant
- 5 years/ 50,000 hrs warranty

Ordering Code Information

PRODUCT	SHAPE	COLOR TEMPERATURE	FINISH	BEAM ANGLE	COLOR RENDERING
CLS75FD	S	27	WH	S	9
CLS75 FD	S Square	27 (2700K) 30 (3000K) 35 (3500K) 40 (4000K)	WH (White) BK (Black)	S (Spot) / 20 deg. M (Medium) / 31 deg. W (Wide) / 41 deg. F (Flood) / 80 deg.	9 (90 CRI+)

Specification sheet

REV.2

CLASSIC 75 FD SQ GEN 2

3 " Architectural Downlight

Photometrics

9W | 90CRI | 3000K | Round

MULTIPLYING FACTORS: (Multiplying Factor is based on 3000K-90+ CRI IES file on website)

CCT	2700K-80+	3000K-80+	3500K-80+	4000K-80+
Factors	1.16	1.19	1.22	1.26

CCT	2700K-90+	3000K-90+	3500K-90+	4000K-90+
Factors	0.97	1.0	1.05	1.08

Spot 20°

Delivered Ourput : 834 lm | CBCP : 3435 cd | Beam Angle : 20°

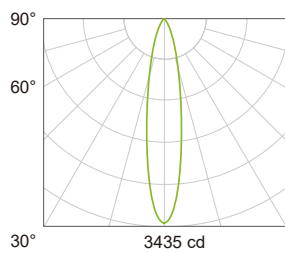

Center Beam Intensity	Beam Width	Height
3435 lx	36cm	1m
856 lx	72cm	2m
382 lx	108cm	3m
215 lx	144cm	4m
137 lx	180cm	5m

Medium 31°

Delivered Ourput : 837 lm | CBCP : 2316 cd | Beam Angle : 31°

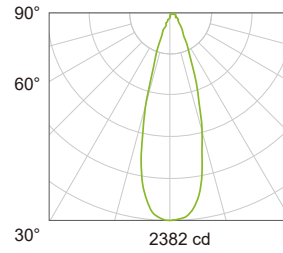

Center Beam Intensity	Beam Width	Height
2365 lx	56cm	1m
591 lx	112cm	2m
263 lx	168cm	3m
148 lx	224cm	4m
95 lx	280cm	5m

Wide 41°

Delivered Ourput : 835 lm | CBCP : 1556 cd | Beam Angle : 41°

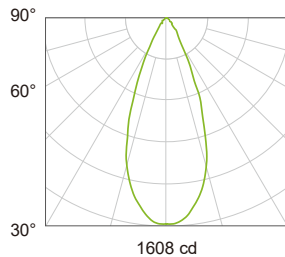

Center Beam Intensity	Beam Width	Height
1597 lx	75cm	1m
399 lx	150cm	2m
177 lx	224cm	3m
100 lx	299cm	4m
64 lx	374cm	5m

Flood 80°

Delivered Ourput : 772 lm | CBCP : 446 cd | Beam Angle : 80°

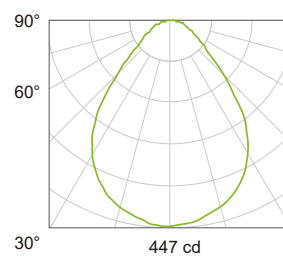

Center Beam Intensity	Beam Width	Height
448 lx	166cm	1m
112 lx	332cm	2m
50 lx	498cm	3m
28 lx	664cm	4m
18 lx	830cm	5m

Recommend LED Driver:

Driver No.	Input Voltage	Dimming	Note
DAE-3-400-18	120-277V	TRIAC/ELV/0-10V	